







20 006 705

- con struttura a CASCATA
- diametro foro 32 mm
- rosetta 60 x 47 mm
- con contrassegno freddo



	Cromato	20 006 705-00
	Platinato spazzolato	20 006 705-06
	Dark Chrome	20 006 705-19
	Champagne spazzolato (Oro 22k)	20 006 705-46
	Champagne (Oro 22k)	20 006 705-47
	Dark Platinum spazzolato	20 006 705-99

20 006 705

mm [inches]

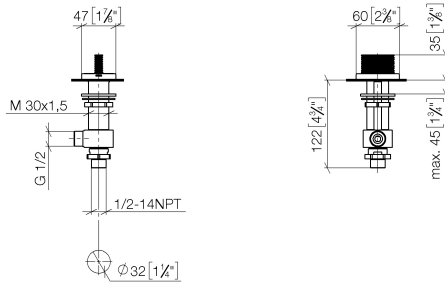

**Diagramma di portata**

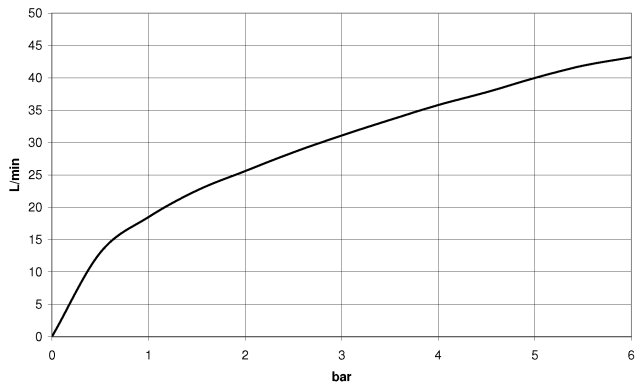

**Certificati**

WRAS\_1804020. IAPMO\_4976 (5). IAPMO\_N-4976. LGA\_28687. IAPMO\_6397.

WRAS\_240202020.

20 006 705

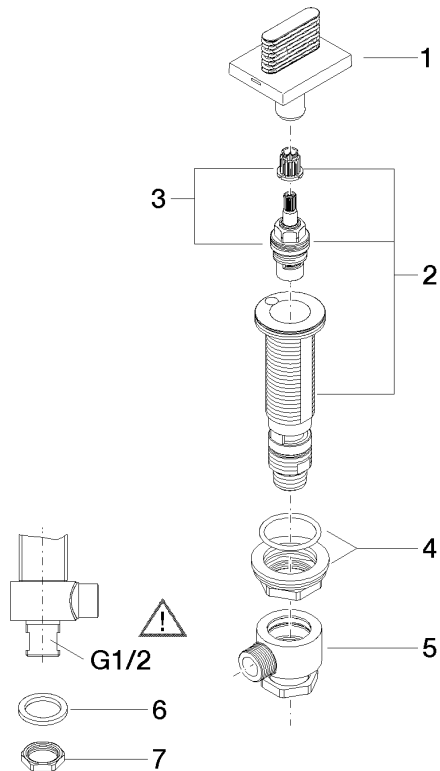

### Elenco delle parti di ricambio

N.	Codice articolo	Denominazione	Quantità necessaria	Tempo di produzione
1	90 20 70 053 06-00	manopola ( cold )	1	10
2	04 17 11 058 53 90	parte laterale	1	2
3	90 90 03 153 00 90	parte superiore	1	2
4	04 23 10 032 78 90	set di fissaggio	1	2
5	04 17 11 023 10 90	distributore	1	2
6	90 23 30 040 00-00	giunto a vite	1	10
7	09 30 11 059 90	rondella	1	2
8	09 23 10 012 90	dado	1	2